

FLASHLIGHTS - PELICAN LIMITED LIFETIME GUARANTEE OF EXCELLENCE

Pelican Products, Inc. guarantees its lights for a lifetime against breakage or defects in workmanship. This guarantee does not cover the lamp or batteries. All warranty claims of any nature are barred if the product has been altered, damaged or in any way physically changed, or subjected to abuse, misuse, negligence or accident. For complete warranty details, see http://www.pelican.com/warranty. In Australia: www.pelican.com/warranty/australia.

REMOTE AREA LIGHTING SYSTEMS - PELICAN

1 YEAR LIMITED WARRANTY FOR RALS PRODUCTS

Pelican Products, Inc. guarantees to the original purchaser of its RALS products that its products will be free of defects in materials and workmanship for one year from the date of purchase. All warranty claims of any nature are barred if the product has been altered, damaged or in any way physically changed, or subjected to abuse, misuse, negligence or accident. For complete warranty details, see http://www.pelican.com/warranty. In Australia: www.pelican.com/warranty/australia.

U.S.A.

CALIFORNIA

23215 Early Avenue
Torrance, CA 90505
Tel: 310.326.4700
800.473.5422
Fax: 310.326.3311
www.pelican.com

MASSACHUSETTS

147 North Main Street
South Deerfield, MA 01373
Tel: 800.542.7344
Fax: 413.665.8330
www.pelican.com

INTERNATIONAL

EUROPE, MIDDLE EAST AND AFRICA

Peli Products, S.L.U.
c/ Provença, 388, Planta 7
Barcelona, Spain, 08025
Tel: +34.934.674.999
Fax: +34.934.877.393
www.peli.com

JAPAN

Pelican Products K.K.
Nisso 22 Bldg 9F
1-11-10 Azabu Dai
Minato ward Tokyo
Japan 106-0041
Tel: +81.33.585.9100
Fax: +81.33.585.9109
www.pelican.com/jp

CANADA

Pelican Products ULC
10221-184th Street
Edmonton, Alberta
T5S 2J4, Canada
Tel: +780.481.6076
Fax: +780.481.9586
www.pelican.ca

AUSTRALIA

Pelican Products Pty Ltd
West Wing, Platinum Building, Suite 2.33
4 Ilya Av
Erina NSW 2250
Tel: +612.4367.7022
Fax: +612.4367.7066
www.pelicanaustralia.com

CHINA

Pelican Products China Representative Office
Pine City Building, Room 1026
777 Zhaojiabang Road
Shanghai, China 200032
Tel: +86.21.64189685
Fax: +86.21.64189679
www.pelican.com/cn

KOREA

Pelican Products Korea Ltd
#909 Hyundai 41 Tower, #2616
917-9, Mok-dong, Yangchon-gu, Seoul, Korea 158-050
Tel: +82.2.6092.4700
Fax: +82.2.6739.4700
www.pelican.com/ko

INDIA and SOUTH ASIA

(Bangladesh, Bhutan, Maldives, Nepal, Sri Lanka)

Pelican Products and Services India Pvt. Ltd.
GF 9&10, Augusta Point
Sector-53, Golf Course Road
Haryana, Gurgaon 122002, India
Tel: +91.124.4377227
Fax: +91.124.4049227
www.pelican.com

SE ASIA and rest of ASIA

(Hong Kong, Macau, Taiwan, Pakistan)

No.777, Pine City Building ZhaoJiaBang Road
#10-26 XuHui District
Shanghai, China 200032
Phone: +86.21.64189685
Fax: +86.21.64189679
www.pelican.com

LATIN AMERICA

23215 Early Avenue
Torrance, California 90505 USA
Tel: +1.310.326.4700 x1462
Fax: +1.310.325.5740
www.pelican.com



DISTRIBUTED BY:



PELICAN
LIGHTS CATALOG
Tough Lighting Tools
JULY 2017



SINCE 1976

JULY 2017



DEAR CUSTOMER,
Lighting tools – they're a core element of every toolbox. They have a straightforward and simple purpose. Yet, when you're in a situation that requires a lighting tool, you want to make sure you have the right one. Pelican understands the critical importance of this tool. We provide a wide range of advanced lighting systems to support professionals, outdoor enthusiasts and everyday do-it-yourself hobbyists. Regardless of the purpose, our lighting tools and remote area lighting systems enable you to accomplish your tasks in a safer and more efficient manner.

With this perspective, Pelican relentlessly pursues innovation for new lighting tool products and manufacturing processes. We have adopted the ANSI FL-1 flashlight standards (see page 1) and continue to increase the number of industry leading safety certificates for specific models.

Our new lighting catalog features multiple technology advances. These include state of the art LED performance upgrades, new electronic features, upgraded safety certificates and enhanced packaging. We are committed to environmentally responsible manufacturing, in fact most of our lights use LED bulbs that help protect our planet. LEDs are long lasting, promote extended battery life and allow for the latest technological advancements.

From basic models to the high-performance 9410L LED Lantern (our brightest handheld flashlight to date) and the 9470 Remote Area Lighting System (which delivers 12,000 lumens), we are ready to provide world-class support for our dealers and end users across the globe. And, all of this comes with Pelican's industry-leading guarantee of excellence.

We invite you to look through our new catalog and discover the ideal lighting tools for your specific needs.

CEO and President
Lyndon Faulkner

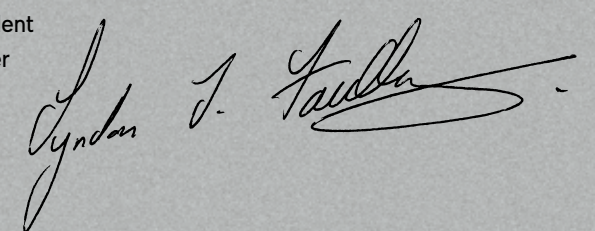

MARKETS SERVED //

FIRE
MILITARY
INDUSTRIAL
LAW ENFORCEMENT
OUTDOOR
CONSUMER
DIVE



©2017 Pelican Products, Inc. All trademarks are registered and/or unregistered trademarks of Pelican Products, Inc., its subsidiaries and/or affiliates. Lexan® is a registered trademark of SABIC. iOS is a registered trademark of Apple, Inc. BLUETOOTH is a registered trademark of Bluetooth Sig, Inc. Android is a trademark of Google Inc. BLACK JACK™ is a trademark of 1445 Designs Corporation. 3M is a trademark of 3M Company

PELICAN LIGHTS

REMOTE AREA LIGHTING SYSTEMS <small>PGS 3 - 6</small>											SMALL LIGHTS <small>PGS 7 - 8</small>														
9420XL	9430	9430SL	9440	9455	9460	9460M	9470	9470M	9480	9490	9500	1810	1830	1900	1910	1920	1930	1965	2140	2220	2300	2340			
MEDIUM LIGHTS <small>PGS 9 - 12</small>																									
1800	1820	2000	2000PL	2010	2010PL	2020	2400	2400PL	2410	2410PL	2430	2450	2460	3310PL	3310ELS	3310R	3315	3315PL	3315R	3325					
LARGE LIGHTS <small>PGS 13 - 16</small>				TACTICAL LIGHTS <small>PGS 15 - 16</small>																					
4000	9410L	9415	2350	2360	2370	2380	2380R	3330	7000	7060	7100	7600	8050	8060											
HEADLAMPS <small>PGS 17 - 20</small>																									
2600	2610	2620	2640	2680	2690	2720	2740	2745	2750	2755	2760	2765	2780	2780R	2785										
RIGHT ANGLE LIGHTS <small>PGS 21 - 24</small>											DIVE LIGHTS <small>PGS 25 - 26</small>				SPECIALTY LIGHTS <small>PGS 27 - 28</small>										
2250	3310R-RA	3315R-RA	3610	3610PL	3660	3700	3700PL	3715	3715PL	3750	3750PL	3765	3765PL	1960N	2010N	2410N	2130	2130IR	2365	2490					



PELICAN LIGHTING TOOLS: MORE THAN JUST FLASHLIGHTS.

Here are just a few features that make our lighting tools shine:



WIRELESS BLUETOOTH™ CONTROL
(on select models only)



SELF PROGRAMMABLE
(on select models only)



GESTURE ACTIVATION
(on select models only)



PHOTOLUMINESCENT DESIGNS
(on select models only)



BATTERY LEVEL INDICATION
(on select models only)



DOWNCAST LIGHTING FEATURES
(on select models only)



SUBMERSIBLE APPLICATIONS
(on select models only)



LEGENDARY LIFETIME GUARANTEE



INTELLIGENT CONTROL
(on select models only)



TABLE OF CONTENTS

PERFORMANCE & SAFETY	1-2
REMOTE AREA LIGHTING SYSTEMS	3-6
SMALL LIGHTS	7-8
MEDIUM LIGHTS	9-12
LARGE LIGHTS	13-14
TACTICAL LIGHTS	15-16
HEADLAMPS	17-20
RIGHT ANGLE LIGHTS	21-24
DIVE LIGHTS	25-26
SPECIALTY LIGHTS	27-28
LIGHT MOUNTING SYSTEMS	29-30
HOLSTERS AND HELMET HOLDERS	
SPECIFICATIONS	31-34
CUSTOM LABELS LIGHTING FEATURES	35-36

PERFORMANCE

ANSI STANDARDS (AMERICAN NATIONAL STANDARDS INSTITUTE)

Why create standards? While Pelican was one of the first manufacturers to use quantifiable test procedures, the need was recognized to develop a common language that customers could use to select the right flashlight for their specific needs. As a result, the American National Standards Institute (ANSI), with input from the

flashlight industry, developed performance standards and symbols to effectively communicate a flashlight's features and benefits.

The resulting ANSI/NEMA FL 1 Standards include the following six criteria:

STANDARDS AND RATINGS (APPLICABLE TO FLASHLIGHTS ONLY)

LIGHT OUTPUT

Light Output is the total luminous flux. It is the total quantity of emitted overall light energy as measured by integrating the entire angular output of the portable light source. Light output in this standard is expressed in units of lumens.

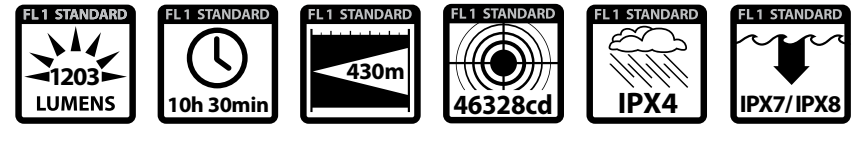

RUN TIME

Run Time is defined as the duration of time from the initial light output value – defined as 30 seconds after the point the device is first turned on – using fresh batteries, until the light output reaches 10% of the initial value.

BEAM DISTANCE

Beam Distance is defined as the distance from the device at which the light beam is 0.25 lux (0.25 lux is approximately the equivalent of the light emitted from the full moon "on a clear night in an open field").

WATER RESISTANT

Water Resistant – IPX4 Water splashed against the device from any direction shall have no harmful effects.

WATERPROOF/SUBMERSIBLE

Water Proof // IPX7 – Ingress of water in quantities causing harmful effects shall not be possible when the enclosure is temporarily immersed in water under standardized conditions of pressure and time. Submersible // IPX8 – Ingress of water in quantities causing harmful effects shall not be possible when the enclosure is continuously immersed in water under conditions which shall be stated by manufacturer, but which are more severe than for IPX7.

PEAK BEAM INTENSITY

Peak Beam Intensity is the maximum luminous intensity typically along the central axis of a cone of light. The value is reported in candela and does not change with distance.

GLOSSARY OF TERMS

Candela A unit of measurement of the intensity of light that is emitted by a light source in a particular direction.

Lux The unit of luminous flux in the International System, equal to the amount of light given out through a solid angle by a source of one candela intensity radiating equally in all directions.

Lumen A unit of measurement of the amount of brightness that comes from a light source. Lumens define "luminous flux," which is energy within the range of frequencies we perceive as light.

Integrating Sphere An integrating sphere is a measurement device with an entrance port that can accept all the directional light output of the device under test, or can totally enclose the device itself. The walls of the sphere should be highly diffused with high reflectivity (>80%) and the spectroradiometer should be shielded from direct view of the device under test by a baffle system.

Rechargeable Denotes a flashlight which contains rechargeable batteries and charging station. These models are shown with the rechargeable icon.



IP (Ingress Protection) – These ratings specify the environmental protection the enclosure provides. The IP rating normally has two numbers (IPXX). The first number represents protection from solid objects or materials (dust) whereas the second number represents protection from liquids (water). With the IP rating IP 54, 5 describes the level of protection from solid objects and 4 describes the level of protection from liquids as described by the IP Rating System (Solids vary from 0-6 IP rating, Liquids vary from 0-8 IP rating).



INTRINSICALLY SAFE. YOUR PASSPORT THROUGH HAZARDOUS LOCATIONS

Whether working in a Class I Oil Refinery or in the silo of a Class III Textile Mill, safety is always a concern and your lighting tool shouldn't add to your worries. Pelican builds lighting tools certified for hazardous work environments. In fact we make more safety approved lights certified for **Class I II III Div. 1** and groups **ABCDEFG** than anyone else. To find the right light for your job visit us at Pelican.com/safety.

HAZARDOUS AREA ELECTRICAL GUIDELINES

	CLASSIFICATIONS	SUBSTANCE	TYPICAL ENVIRONMENTS
CLASS I	DIVISION 1	Flammable Gases, Vapors, or Liquids	Oil Refinery, Paint Warehouse Spray Booth, Offshore Oil Rig
	DIVISION 2		
CLASS II	DIVISION 1	Combustible Dusts	Coal Mine, Munitions Factory, Grain Silo, Hay Storage Facility
	DIVISION 2		
CLASS III	DIVISION 1	Ignitable Fibers & Flyings	Paper Mill, Woodworking Facility, Textile Mill, Cotton Gin
	DIVISION 2		

Division 1 (hazard likely): Where volatile substances can exist all of the time or some of the time under normal operating conditions.
Division 2 (hazard not likely): Where volatile substances are not likely to exist under normal operating conditions.

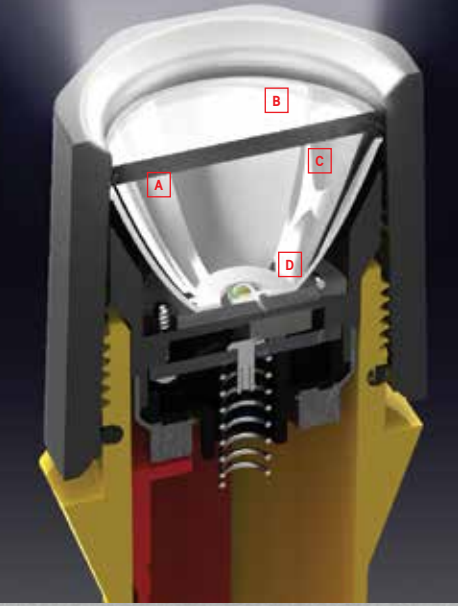

NEW DEEP MOUNT LED TECHNOLOGY

Our engineering team has designed a new high performance LED lamp module (Deep Mount LED Module). These lights are now brighter, with close to 100% increase in lumens and a 2.5 times increase in lux value over previous versions (as well as offering a more robust design).

- A** New deep dish reflector provides up to 2.5 times lux increase, and 100% lumen increase
- B** Robust, over-molded polycarbonate lens won't yellow
- C** Opti-mechanical design gathers and focuses 100% of the light
- D** LED is mounted directly to the PCB board, creating a strong and efficient design solution



RAALS

REMOTE AREA LIGHTING SYSTEMS

Providing increased performance, safer working conditions, emergency preparedness and greater flexibility, Pelican's RAALS line is the modern alternative to generator based lighting:

- Silent performance
- No exhaust fumes
- No flammable fuel
- Remote activation
- Eliminated trip hazards
- Little to no heat

9420XL RAALS

LIGHT SOURCE // LED
 BATTERIES // Lithium ion
 DIMENSIONS // 29" (73.6 cm) Closed, 62" (157.4 cm) Deployed
 MODES // High / Low
 BEAM SPREAD // 58°, 2 LEDs per head

LUMENS
1000
 RUN TIME
4h
 UP TO



9430 RAALS

LIGHT SOURCE // LED
 BATTERIES // Sealed Lead Acid
 DIMENSIONS // 15.75" (40 cm) Closed, 32.28" (82 cm) Extended
 MODES // High / Low
 BEAM SPREAD // 125°, 6 LEDs

LUMENS
3000
 RUN TIME
15h
 UP TO



9430SL SPOT LIGHT RAALS

LIGHT SOURCE // LED
 BATTERIES // Sealed Lead Acid
 DIMENSIONS // 15.75" (40 cm) Closed, 32.28" (82 cm) Extended
 MODES // High / Low
 BEAM SPREAD // 10°, 24 LEDs

LUMENS
2000
 RUN TIME
15h
 UP TO



9440 RAALS

LIGHT SOURCE // LED
 BATTERIES // Lithium-Ion
 DIMENSIONS // 37.4" (95 cm) Closed, 85" (215.8 cm) Extended
 MODES // High / Medium / Low
 BEAM SPREAD // 120°, 10 LEDs

LUMENS
5300
 RUN TIME
8h
 UP TO



Bluetooth

9455 SAFETY LIGHT RAALS

LIGHT SOURCE // LED
 BATTERIES // NiMH
 DIMENSIONS // 15.35" (39 cm) Closed, 31.50" (80 cm) Extended
 MODES // High / Low / Flashing
 BEAM SPREAD // 125°, 10 LEDs
 CERTIFICATIONS // CI, D1, IECEx ia, ATEX Zone 0

LUMENS
1600
 RUN TIME
10h
 UP TO



NEW

9500 SHELTER LIGHTING SYSTEM

LIGHT SOURCE // LED
 INPUT VOLTAGE // 12 - 30vdc or 110-240vac
 DIMENSIONS // 20.62" (52.4 cm) Closed, 157.5" (399.9 cm) Extended
 LIGHT OUTPUT // 6000 (White LED) Per Head, 1200 (Red LED) Per Head
 BEAM SPREAD // 210° Diffused, 36 LEDs per head (24 White/12 Red), 3 lamp heads
 PELICAN CASE // Included

LUMENS
6000
 UP TO



Select between white light or red night vision mode

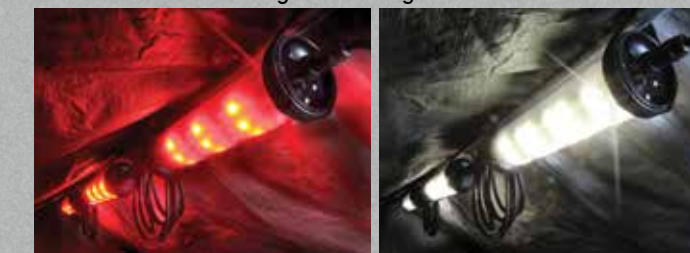

9460/9460M RALS

LIGHT SOURCE // LED
BATTERIES // Sealed Lead Acid
DIMENSIONS // 23.25" (59.1 cm) Closed, 79.50" (201.9 cm) Deployed
MODES // Variable Light Output / Flashing / 3 Preset Levels
BEAM SPREAD // 120°, 10 LEDs per head, 2 lamp heads



INTELLIGENT CONTROL SYSTEM
 calculates and displays current battery life, allowing the user to regulate the intensity of the light and choose the desired run time.



9460



9460M



9460, 9460M, 9470, 9470M FEATURES



12V POWER SUPPLY WITH DUAL USB ADAPTER
 12 volt power supply port can be used to power any electrical product that utilizes a standard 12v vehicle style connector (up to 4 amps) or a variety of USB connections.



BLUETOOTH™ CONTROL
 Bluetooth app controls multiple units and variable light from 0-100% output. Free App for iOS™ and Android™.



MULTI-TERRAIN TROLLEY (ONLY ON 9460M, 9470M)
 Large 1.5 inch polyurethane wheels allow for easier transport across rough surfaces. Molded feet level and stabilize case.

9480 RALS

LIGHT SOURCE // LED
BATTERIES // Sealed Lead Acid
DIMENSIONS // 15.50" (39.4 cm) Closed, 23.75" (60.3 cm) Deployed
MODES // High / Medium / Low / Flashing
BEAM SPREAD // 125°, 8 LEDs

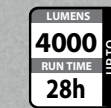

SWAPPABLE POWER PACK
 Swappable power pack w/12v aux. port adapter powers smartphones, laptops, etc.



9490 RALS

LIGHT SOURCE // LED
BATTERIES // Sealed Lead Acid
DIMENSIONS // 20" (50.8 cm) Closed, 72" (182.9 cm) Deployed
MODES // High / Medium / Low / Flashing / (6000-Variable)
BEAM SPREAD // 125°, 10 LEDs

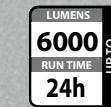

INTELLIGENT CONTROL SYSTEM
 calculates and displays current battery life, allowing the user to regulate the intensity of the light and choose the desired run time.

BATTERY LEVEL INDICATOR
 Full time battery level indication.



9470/9470M RALS

LIGHT SOURCE // LED
BATTERIES // Sealed Lead Acid
DIMENSIONS // 24.75" (62.9 cm) Closed, 80.00" (208.3 cm) Deployed
MODES // Variable Light Output / Flashing / 3 Preset Levels
BEAM SPREAD // 120°, 10 LEDs per head, 4 lamp heads

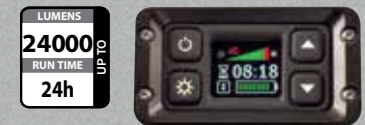

INTELLIGENT CONTROL SYSTEM
 calculates and displays current battery life, allowing the user to regulate the intensity of the light and choose the desired run time.



9470

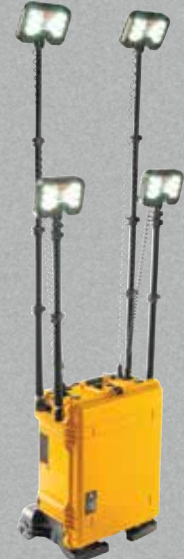

9470M

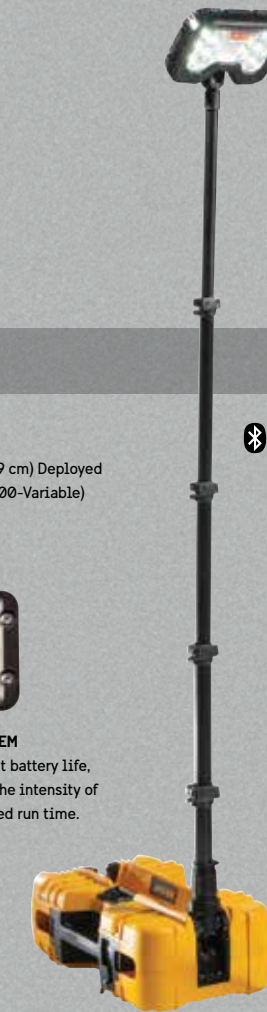

BLUETOOTH™ CONTROL
 Bluetooth app controls multiple units and variable light from 0-100% output Free App for iOS™ and Android™.



SMALL LIGHTS

When compact size is a must or just a convenience, choose from Pelican's range of powerful lights. Whether composite or alloy, certified or colored, you'll find the perfect model for your next job.



1810

LIGHT SOURCE // LED
BATTERIES // 4 LR 41 Alkaline (included)
LENGTH // 1.50" (3.8 cm)

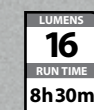

L4™ 1830

LIGHT SOURCE // LED
BATTERIES // 3 AAAA Alkaline (included)
LENGTH // 6.2" (15.7cm)
CERTIFICATIONS // CI, D1

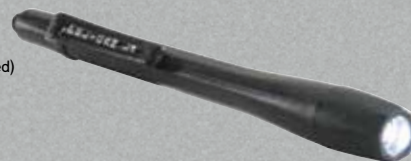

MITYLITE™ 1900

LIGHT SOURCE // Incandescent (Xenon)
BATTERIES // 2 AAA Alkaline (included)
LENGTH // 4.09" (10.4cm)
CERTIFICATIONS // CI, D1/CII, D2



1910

LIGHT SOURCE // LED
BATTERIES // 1 AAA Alkaline (included)
LENGTH // 3.8" (9.7cm)
MODES // High / Low

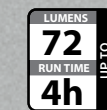
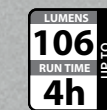

1920

LIGHT SOURCE // LED
BATTERIES // 2 AAA Alkaline (included)
LENGTH // 5.5" (14.0cm)
MODES // High / Low



L1™ 1930

LIGHT SOURCE // LED
BATTERIES // 4 LR 44 Alkaline (included)
LENGTH // 2.64" (6.7cm)
CERTIFICATIONS // CI, D1/CII, D2



MITYLITE™ 1965

LIGHT SOURCE // LED
BATTERIES // 2 AAA Alkaline (included)
LENGTH // 5.48" (13.9cm)
CERTIFICATIONS // CI II III, D1



TRACKER™ 2140

LIGHT SOURCE // Incandescent (Xenon)
BATTERIES // 2 AAA Alkaline (included)
LENGTH // 3.5" (8.9 cm)
CERTIFICATIONS // CI, D2

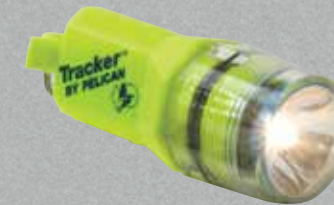

VB3™ 2220

LIGHT SOURCE // LED
BATTERIES // 2 CR2032 Lithium (included)
LENGTH // 3.5" (8.9cm)
CERTIFICATIONS // CI, D1



1810

LIGHT SOURCE // LED
BATTERIES // 4 LR 41 Alkaline (included)
LENGTH // 1.50" (3.8 cm)

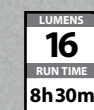

L4™ 1830

LIGHT SOURCE // LED
BATTERIES // 3 AAAA Alkaline (included)
LENGTH // 6.2" (15.7cm)
CERTIFICATIONS // CI, D1



MITYLITE™ 1900

LIGHT SOURCE // Incandescent (Xenon)
BATTERIES // 2 AAA Alkaline (included)
LENGTH // 4.09" (10.4cm)
CERTIFICATIONS // CI, D1/CII, D2



MITYLITE™ 2300

LIGHT SOURCE // Incandescent (Xenon)
BATTERIES // 2 AA Alkaline (included)
LENGTH // 5.62" (14.3cm)
CERTIFICATIONS // CI, D1/CII, D2



MITYLITE™ 2340

LIGHT SOURCE // Incandescent (Xenon)
BATTERIES // 2 AA Alkaline (not included)
LENGTH // 6.25" (15.9cm)
CERTIFICATIONS // CI II, D2



MEDIUM LIGHTS

Nothing beats the versatility of a hand-held light. Easy to carry, stash in a pocket, or clip to a helmet, these lights do just about everything. And when hazardous areas are present, you can count on Pelican's line of safety certified lighting tools. You'll even find photoluminescent models made with "glow-in-the-dark" material to help you find your flashlight in an emergency.



PELILITE™ 1800

LIGHT SOURCE //
Incandescent (Xenon)
BATTERIES //
2 C Alkaline (not included)
LENGTH //
6" (15.2cm)
CERTIFICATIONS //
CI II, D2



POCKET SABRE™ 1820

LIGHT SOURCE //
Incandescent (Xenon)
BATTERIES //
2 C Alkaline (included)
LENGTH //
5.83" (14.8cm)
CERTIFICATIONS //
CI II III, D2



SABRELITE™ 2000

LIGHT SOURCE //
Incandescent (Xenon)
BATTERIES //
3 C Alkaline (not included)
LENGTH //
7.79" (19.8cm)
CERTIFICATIONS //
CI, D1/CII, D2



SABRELITE™ 2000PL PHOTOLUMINESCENT SHROUD

LIGHT SOURCE //
Incandescent (Xenon)
BATTERIES //
3 C Alkaline (not included)
LENGTH //
7.79" (19.8cm)
CERTIFICATIONS //
CI, D1/CII, D2



SABRELITE™ 2010

LIGHT SOURCE //
LED
BATTERIES //
3 C Alkaline (not included)
LENGTH //
8.11" (20.6cm)
CERTIFICATIONS //
CI II III, D1



SABRELITE™ 2010PL PHOTOLUMINESCENT SHROUD

LIGHT SOURCE //
LED
BATTERIES //
3 C Alkaline (not included)
LENGTH //
8.11" (20.6cm)
CERTIFICATIONS //
CI II III, D1



SABRELITE™ 2020

LIGHT SOURCE //
Recoil™ LED
BATTERIES //
3 C Alkaline (not included)
LENGTH //
8.75" (22.2cm)
CERTIFICATIONS //
CI, D1



STEALTHLITE™ 2400

LIGHT SOURCE //
Incandescent (Xenon)
BATTERIES //
4 AA Alkaline (included)
LENGTH //
6.49" (16.5cm)
CERTIFICATIONS //
CI, D1/CII, D2



STEALTHLITE™ 2400PL PHOTOLUMINESCENT SHROUD

LIGHT SOURCE //
Incandescent (Xenon)
BATTERIES //
4 AA Alkaline (included)
LENGTH //
6.49" (16.5cm)
CERTIFICATIONS //
CI D1, CII D2



STEALTHLITE™ 2410 LED

LIGHT SOURCE // LED
BATTERIES // 4 AA Alkaline (included)
LENGTH // 7" (17.8cm)
CERTIFICATIONS // CI II III, D1



STEALTHLITE™ 2410PL PHOTOLUMINESCENT SHROUD

LIGHT SOURCE // LED
BATTERIES // 4 AA Alkaline (included)
LENGTH // 7" (17.8cm)
CERTIFICATIONS // CI, II, III D1



MITYLITE™ 2430

LIGHT SOURCE // Incandescent (Xenon)
BATTERIES // 4 AA Alkaline (included)
LENGTH // 6.50" (16.5cm)
CERTIFICATIONS // CI, D2



STEALTHLITE™ 2450

LIGHT SOURCE // Incandescent (Xenon)
BATTERIES // NiMH (included)
LENGTH // 6.5" (16.5cm)
CERTIFICATIONS // CI II, D2



STEALTHLITE™ 2460

LIGHT SOURCE // LED
BATTERIES // NiMH (included)
LENGTH // 7" (17.8cm)
CERTIFICATIONS // CI II, D2



3310PL PHOTOLUMINESCENT

LIGHT SOURCE // LED
BATTERIES // 3 AA Alkaline (included)
LENGTH // 6.14" (15.6cm)
MODES // High / Low / Flashing (flashlight body glows in the dark)
(Photoluminescent)



3310 ELS (EMERGENCY LIGHTING SYSTEM)

LIGHT SOURCE // LED
BATTERIES // 3 AA Alkaline (included)
LENGTH // 6.14" (15.6cm)
INCLUDES // 3310PL and Wall Mountable Case (flashlight body glows in the dark)
(Photoluminescent)



3310R

LIGHT SOURCE // LED
BATTERIES // Lithium-Ion (included)
LENGTH // 6.11" (15.5cm)
MODES // Boost / High / Low

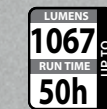

3315

LIGHT SOURCE // LED
BATTERIES // 3 AA Alkaline (included)
LENGTH // 6.14" (11.8cm)
CERTIFICATIONS // CI II III, D1



3315PL PHOTOLUMINESCENT

LIGHT SOURCE // LED
BATTERIES // 3 AA Alkaline (included)
LENGTH // 6.14" (11.8cm)
CERTIFICATIONS // CI II III, D1
(Photoluminescent)



3315R

LIGHT SOURCE // LED
BATTERIES // Lithium-Ion (included)
LENGTH // 6.11" (15.5cm)
CERTIFICATIONS // CI, D1



3325

LIGHT SOURCE // LED
BATTERIES // 3 AA Alkaline (included)
LENGTH // 6.06" (15.4cm)
CERTIFICATIONS // CI, D1, IECEx ia



LARGE LIGHTS

Colossal performance with lightweight designs. Features like full time battery level indication, articulating light head and multiple light modes keep you in control of the job. Pelican is also a leader of high performance lithium-ion technology in portable lighting.



KINGLITE™ 4000

LIGHT SOURCE //
Incandescent (Xenon)
BATTERIES //
8 D Alkaline (not included)
LENGTH //
9.37" (23.8cm)
CERTIFICATIONS //
CI II, D2



9410L LED LANTERN

LIGHT SOURCE //
LED
BATTERIES //
Lithium-Ion (included)
LENGTH //
8.75" (22.2 cm)
MODES //
High / Low / Flashing
Full Time Battery Indicator



9415 LED LANTERN

LIGHT SOURCE //
LED
BATTERIES //
NiMH (included)
LENGTH //
8.75" (22.2cm)
CERTIFICATIONS //
CI, D1
MODES //
High / Low / Flashing
Full Time Battery Indicator

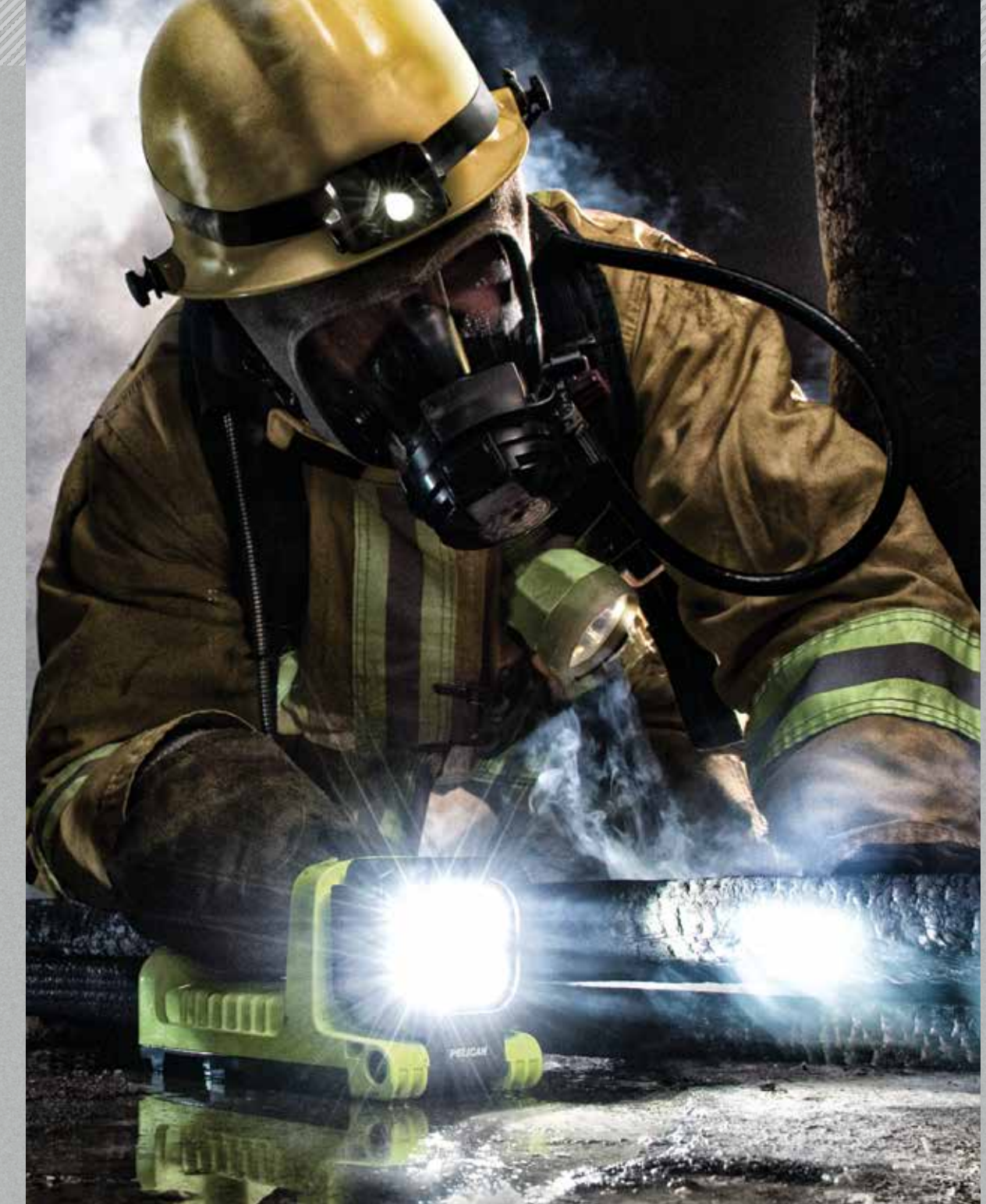

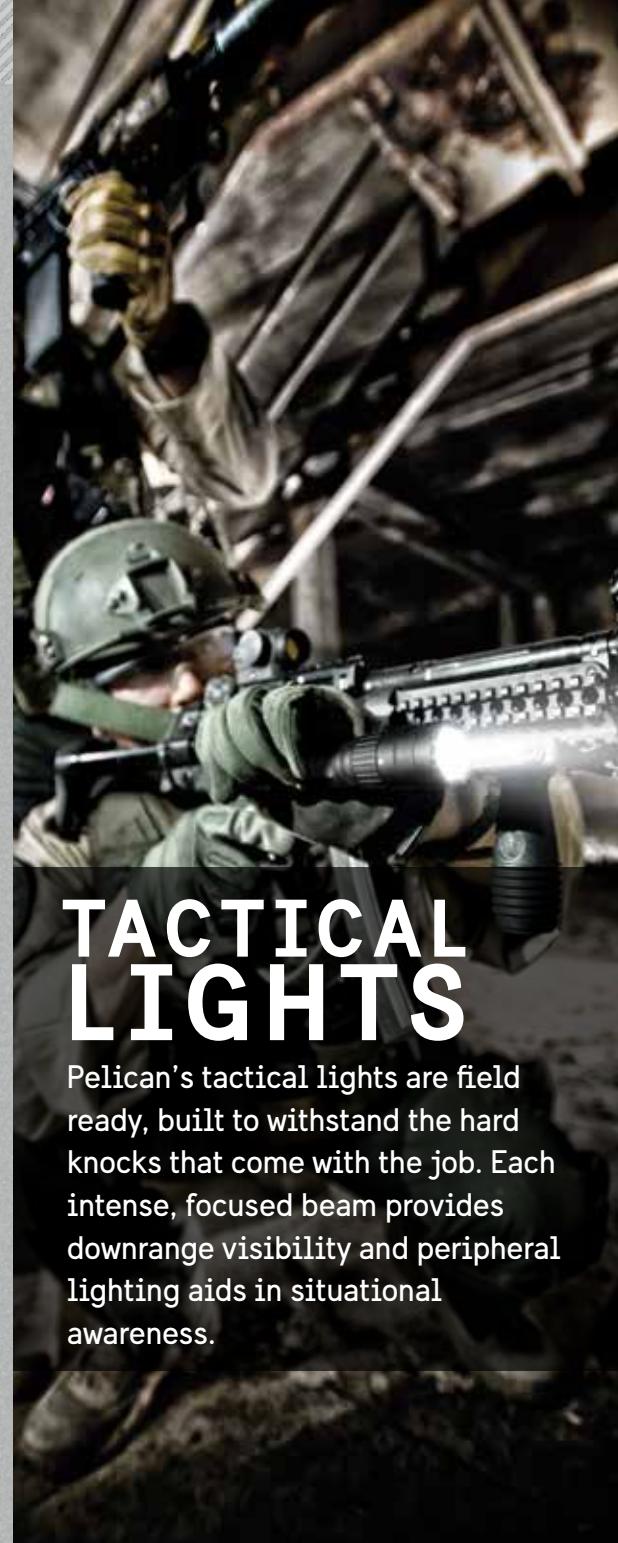

TACTICAL LIGHTS

Pelican's tactical lights are field ready, built to withstand the hard knocks that come with the job. Each intense, focused beam provides downrange visibility and peripheral lighting aids in situational awareness.

2350

LIGHT SOURCE // LED
 BATTERIES // 1 AA Alkaline (included)
 LENGTH // 4.23" (10.7 cm)
 MODES // High / Strobe / Low



LUMENS
178
RUN TIME
21h
UP TO

2360 LED

LIGHT SOURCE // LED
 BATTERIES // 2 AA Alkaline (included)
 LENGTH // 6.2" (15.7cm)
 MODES // High / Strobe / Low



LUMENS
375
RUN TIME
13h
UP TO

2370

LIGHT SOURCE // LED
 BATTERIES // 2 AA Alkaline (included)
 LENGTH // 6.43" (16.3cm)
 MODES // High / Low / Red / Blue
 LIGHT COLORS // White / Red / Blue



LUMENS
358
RUN TIME
11h
UP TO

2380

LIGHT SOURCE // LED
 BATTERIES // 2 AA Alkaline (included)
 LENGTH // 6.44" (16.4cm)
 MODES // High / Low / Spot To Flood



LUMENS
372
RUN TIME
13h
UP TO

2380R

LIGHT SOURCE // LED
 BATTERIES // Lithium-Ion (included)
 LENGTH // 6.48" (16.5 cm)
 MODES // High / Strobe / Low
 Spot To Flood



USB
LUMENS
305
RUN TIME
25h
UP TO

PM6 3330

LIGHT SOURCE // LED
 BATTERIES // 2 CR123 Lithium-Ion (included)
 LENGTH // 5.27" (13.4cm)



LUMENS
90
RUN TIME
4h 45m
UP TO

7000

LIGHT SOURCE // LED
 BATTERIES // 2 CR123 Lithium-Ion
 LENGTH // 5.31" (13.5 cm)
 MODES // High / Strobe / Medium / Low
 Self Programmable



LUMENS
774
RUN TIME
13h
UP TO

7060

LIGHT SOURCE // LED
 BATTERIES // Lithium-Ion (included)
 LENGTH // 8.65" (22cm)
 MODES // High / Strobe / Medium / Low
 Self Programmable



LUMENS
368
RUN TIME
45h
UP TO

7100

LIGHT SOURCE // LED
 BATTERIES // Lithium-Ion (included)
 LENGTH // 5.12" (13cm)
 MODES // High / Strobe / Medium / Low
 PROGRAMMABLE // 5 Selectable Programs



USB
LUMENS
695
RUN TIME
9h 15m
UP TO

7600

LIGHT SOURCE // LED
 BATTERIES // Lithium-Ion (included)
 LENGTH // 6.19" (15.7cm)
 MODES // High / Strobe / Medium / Low
 LED COLORS // White / Red / Green
 PROGRAMMABLE // 5 Selectable Programs



USB
LUMENS
944
RUN TIME
29h
UP TO

M11 8050

LIGHT SOURCE // Incandescent (Xenon)
 BATTERIES // NiMH (included)
 LENGTH // 11.25" (28.6cm)



LUMENS
164
RUN TIME
2h 15m
UP TO

8060

LIGHT SOURCE // LED
 BATTERIES // NiMH (included)
 LENGTH // 12.67" (32.2cm)
 MODES // High / Strobe / Medium / Low
 Flashing / Self Programmable



LUMENS
803
RUN TIME
69h
UP TO





HEADLAMPS

With up to 500 lumens, revolutionary downcast lighting, USB charging and battery level indication, these headlamps are packed with features. Other options, including night vision friendly red illumination, interchangeable body colors and multiple settings, make these headlamps your best partner for the dark.

HEADSUP LITE™ 2600

LIGHT SOURCE //
Incandescent (Krypton)
BATTERIES //
4 AA Alkaline (included)
LENGTH //
3.81" (9.7cm)
CERTIFICATIONS //
CI II III, D2



HEADSUP LITE™ 2620

LIGHT SOURCE //
Incandescent (Xenon), LED
BATTERIES //
3 AAA Alkaline (included)
LENGTH //
2.16" (5.5cm)
CERTIFICATIONS //
CI, D1
MODES //
High / Low



HEADSUP LITE™ 2640

LIGHT SOURCE //
Incandescent (Halogen), LED
BATTERIES //
4 AA Alkaline (included)
LENGTH //
2.63" (6.7cm)
CERTIFICATIONS //
CI, D2
MODES //
High / Low



HEADSUP LITE™ 2680

LIGHT SOURCE //
Recoil™ LED
BATTERIES //
4 AA Alkaline (included)
LENGTH //
4.64" (11.8cm)
CERTIFICATIONS //
CI II III, D2



HEADSUP LITE™ 2610

LIGHT SOURCE //
LED
BATTERIES //
3 AAA Alkaline (included)
LENGTH //
1.49" (3.8cm)
CERTIFICATIONS //
CI, D1
MODES //
High / Low



HEADSUP LITE™ 2690

LIGHT SOURCE //
LED
BATTERIES //
3 AAA Alkaline (included)
LENGTH //
2.81" (7.1 cm)
CERTIFICATIONS //
CI II III, D1



2720 HEADLAMP

LIGHT SOURCE //
LED
BATTERIES //
3 AAA Alkaline (included)
LENGTH //
2.48" (6.3 cm)
MODES //
Variable Light Output / Spot to Flood /
Red Night Vision Friendly LEDs

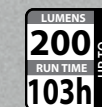

GESTURE
ACTIVATION
CONTROL

2740 HEADLAMP

LIGHT SOURCE //
LED
BATTERIES //
3 AAA Alkaline (included)
LENGTH //
2.25" (5.7 cm)
MODES //
High / Low /
Flashing / Red LED

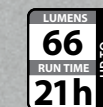

(Translucent Blue)

2745 HEADLAMP

LIGHT SOURCE //
LED
BATTERIES //
3 AAA Alkaline (included)
LENGTH //
2.25" (5.7 cm)
CERTIFICATIONS //
CI, D1
MODES //
High / Low / Flashing



2750 HEADLAMP

LIGHT SOURCE //
LED
BATTERIES //
3 AAA Alkaline (included)
LENGTH //
2.25" (5.7 cm)
MODES //
High / Low / Flashing / Red LED /
Low Battery Warning



2755 HEADLAMP

LIGHT SOURCE //
LED
BATTERIES //
3 AAA Alkaline (included)
LENGTH //
2.25" (5.7 cm)
CERTIFICATIONS //
CI, D1
MODES //
High / Low / Flashing /
Low Battery Warning



2780R HEADLAMP

LIGHT SOURCE //
LED
BATTERIES //
Lithium-Ion (included)
LENGTH //
3.00" (7.6 cm)
MODES //
High / Medium / Low /
Flashing / Downcast /
Full-time Battery
Level Indicator



NEW

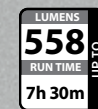

2760 HEADLAMP

LIGHT SOURCE //
LED
BATTERIES //
3 AAA Alkaline (included)
LENGTH //
2.25" (5.7 cm)
MODES //
High / Medium / Low /
Downcast / Flashing/
Red LED / Full-time Battery
Level Indicator



2765 HEADLAMP

LIGHT SOURCE //
LED
BATTERIES //
3 AAA Alkaline (included)
LENGTH //
2.25" (5.7 cm)
CERTIFICATIONS //
CI, D1
MODES //
High / Low / Flashing / Downcast



2780 HEADLAMP

LIGHT SOURCE //
LED
BATTERIES //
4 AA Alkaline (included)
LENGTH //
3.00" (7.6 cm)
MODES //
High / Medium /
Low / Flashing / Downcast/
Full-time Battery
Level Indicator



2785 HEADLAMP

LIGHT SOURCE //
LED
BATTERIES //
4 AA Alkaline (included)
LENGTH //
3.00" (7.6 cm)
CERTIFICATIONS //
CI, D1
MODES //
High / Medium / Low /
Flashing / Downcast



NEW





RIGHT ANGLE / ARTICULATING LIGHTS

Firefighters put everything on the line and the correct lighting tools are critical. Right angle (90°) and adjustable head flashlights often worn on turnout coats offer hands-free performance. With extreme peak beam intensity and smoke-cutting penetration, these lights will get you in and out of tough situations safely.

VERSABRITE™ 2250

LIGHT SOURCE //
Incandescent (Xenon)
BATTERIES //
2 AA Alkaline (included)
LENGTH //
3.87" (9.8cm)
CERTIFICATIONS //
CI II, D2



3310R-RA

LIGHT SOURCE //
LED
BATTERIES //
Lithium-Ion (included)
LENGTH //
8.27" (21cm)
MODES //
Boost / High / Low



3315R-RA

LIGHT SOURCE //
LED
BATTERIES //
Lithium-Ion (included)
LENGTH //
6.11" (15.5cm)
CERTIFICATIONS //
CI, D1



LITTLE ED™ 3610

LIGHT SOURCE //
LED
BATTERIES //
4 AA Alkaline (included)
LENGTH //
7.51" (19.1cm)
CERTIFICATIONS //
CI II III, D1



LITTLE ED™ 3610PL PHOTOLUMINESCENT SHROUD

LIGHT SOURCE //
LED
BATTERIES //
4 AA Alkaline (included)
LENGTH //
7.51" (19.1cm)
CERTIFICATIONS //
CI II III, D1



LITTLE ED™ 3660

LIGHT SOURCE //
LED
BATTERIES //
NiMH (included)
LENGTH //
7.51" (19.1cm)
CERTIFICATIONS //
CI II, D2



BIG ED™ 3700

LIGHT SOURCE //
Incandescent (Krypton)
BATTERIES //
4 C Alkaline (not included)
LENGTH //
7" (17.8cm)
MODES //
High / Backup
CERTIFICATIONS //
CI, D2



BIG ED™ 3700PL PHOTOLUMINESCENT SHROUD

LIGHT SOURCE //
Incandescent (Krypton)
BATTERIES //
4 C Alkaline (not included)
LENGTH //
7" (17.8cm)
CERTIFICATIONS //
CI, D2
MODES //
High / Backup





3715

LIGHT SOURCE // LED
 BATTERIES // 4 AA Alkaline (not included)
 LENGTH // 5.36" (13.6cm)
 CERTIFICATIONS // CI, D1
 MODES // High / Low / Flashing / Downcast



BIG ED™ 3750

LIGHT SOURCE // Incandescent (Krypton)
 BATTERIES // NiCad (included)
 LENGTH // 7" (17.8cm)
 CERTIFICATIONS // CI, D2
 MODES // High / Backup



3765

LIGHT SOURCE // LED
 BATTERIES // NiMH (included)
 LENGTH // 5.36" (13.6cm)
 CERTIFICATIONS // CI, D1(w/alkalines) / CI, D2
 MODES // High / Low / Flashing / Downcast



3715PL

PHOTOLUMINESCENT SHROUD

LIGHT SOURCE // LED
 BATTERIES // 4 AA Alkaline (not included)
 LENGTH // 5.36" (13.6cm)
 CERTIFICATIONS // CI, D1
 MODES // High / Low / Flashing / Downcast



BIG ED™ 3750PL

PHOTOLUMINESCENT SHROUD

LIGHT SOURCE // Incandescent (Krypton)
 BATTERIES // NiCad (included)
 LENGTH // 7" (17.8cm)
 CERTIFICATIONS // CI, D2
 MODES // High / Backup



3765 PL

PHOTOLUMINESCENT SHROUD

LIGHT SOURCE // LED
 BATTERIES // NiMH (included)
 LENGTH // 5.36" (13.6cm)
 CERTIFICATIONS // CI, D1(w/alkalines)/CI, D2
 MODES // High / Low / Flashing / Downcast



DIVE LIGHTS

Whether you'll be exploring underwater caves and crevices during daylight hours or enjoying the exhilarating adventure of a night dive, Pelican's Nemo™ line of dive lights will fill your needs. Designed to support depths up to 100 meters and built Pelican tough, you'll appreciate the reliability these underwater tools provide.



NEMO™ 1960N PHOTOLUMINESCENT SHROUD

LIGHT SOURCE //
LED
BATTERIES //
2 AAA Alkaline (included)
LENGTH //
5.48" (13.9cm)
SUBMERSIBLE //
100 Meters



LUMENS
34
RUN TIME
3h 30m



NEMO™ 2010N PHOTOLUMINESCENT SHROUD

LIGHT SOURCE //
LED
BATTERIES //
3 C Alkaline (not included)
LENGTH //
8.11" (20.6cm)
SUBMERSIBLE //
100 Meters



LUMENS
161
RUN TIME
22h



NEMO™ 2410N PHOTOLUMINESCENT SHROUD

LIGHT SOURCE //
LED
BATTERIES //
4 AA Alkaline (included)
LENGTH //
7" (17.8cm)
SUBMERSIBLE //
100 Meters



LUMENS
183
RUN TIME
5h 45m

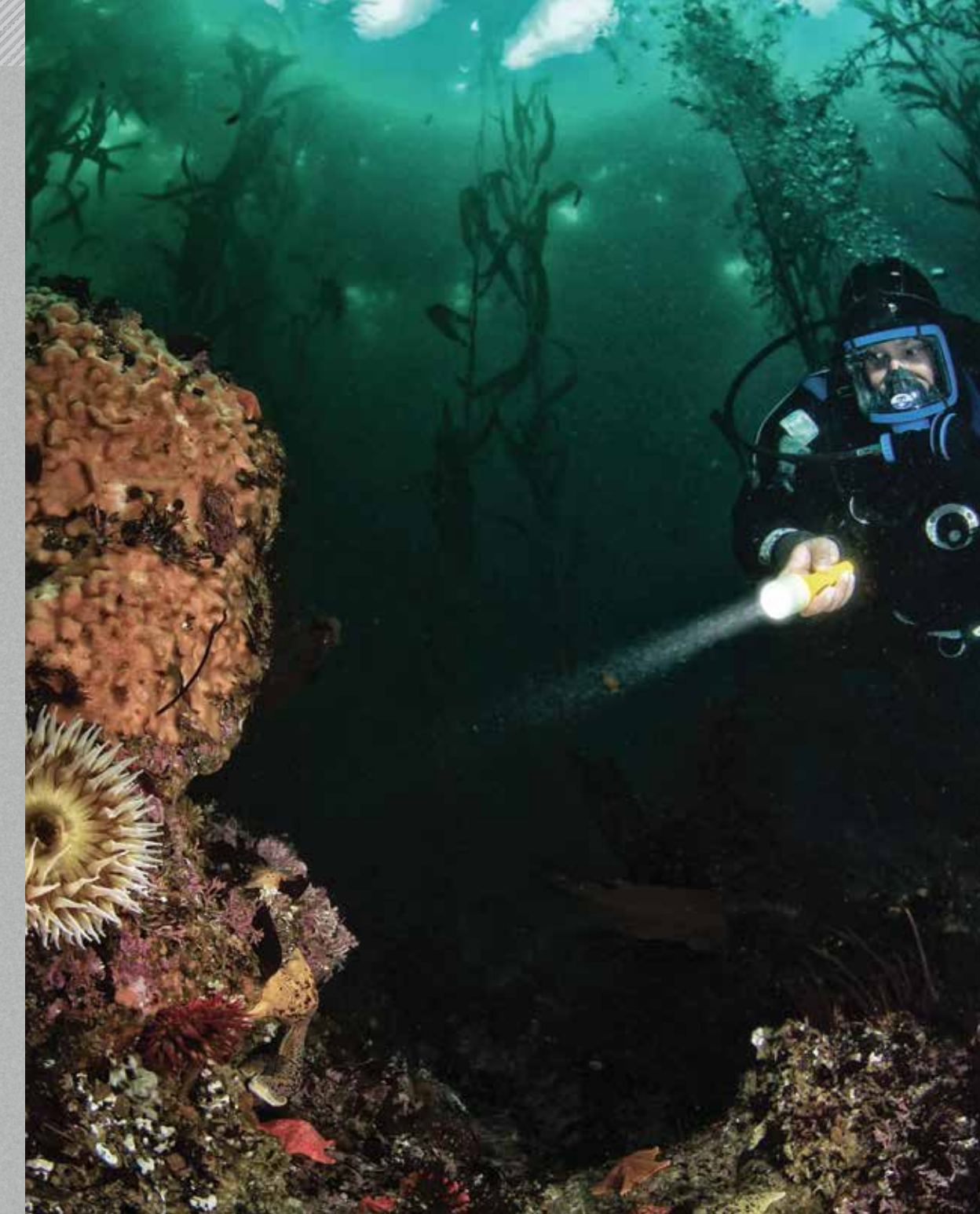

SPECIALTY LIGHTS

Whether directing fighter jets on the deck of aircraft carrier or protecting our troops with friend-or-foe infrared beacons, Pelican manufactures quality lighting tools for many unique military applications. Also available, magnetically secured flexible neck designs for mechanics and red LED flashers that are helpful in keeping workers safe.

MINI FLASHER™ 2130

LIGHT SOURCE //
LED
BATTERIES //
2 L1154 Alkaline (included)
LENGTH //
1.73" (4.4 cm)



MINI FLASHER™ 2130IR

LIGHT SOURCE //
LED (infrared)
BATTERIES //
2 L1154 Alkaline (included)
LENGTH //
1.73" (4.4 cm)

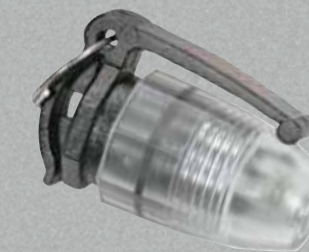

2365 FLEX NECK

LIGHT SOURCE //
LED
BATTERIES //
2 AA Alkaline (not included)
LENGTH //
21.92" (55.7cm)



2490 (WITH TRAFFIC WAND)

LIGHT SOURCE //
Recoil™ LED
BATTERIES //
4 AA Alkaline (not included)
LENGTH //
12.5" (31.7 cm)



LIGHT WEAPON MOUNTING SYSTEMS



CAT. NO. 631

FOREGRIP MOUNT
Fits Pelican Light 7000.



CAT. NO. 7006

REMOTE PRESSURE SWITCH
Our tactical pressure switch replaces the standard tailcap on the flashlight. A 6" cord attached to a 2" pressure-sensitive switch mounts to the foregrip. Fits Pelican Light 7000 (Cat. No. 7006).
COLOR: Black // WT.: 2.0 oz.



NEW PELICAN™ HELMET HOLDERS BY BLACK JACK™ FLASHLIGHT HOLDER
Tough aluminum mounts are built to hold the flashlight under the brim of the helmet, parallel to the line of sight of the user.
Cat. No. #780, 781, 782



NEW PELICAN™ HEAD STRAP RETAINERS BY BLACK JACK™
Set of four high temperature composite clips that utilize a 3M™ adhesive and will attach to any helmet.
CAT. No. 783

	CAT. NO. 2327 Nylon Holster	CAT. NO. 2357/2367 Nylon Holster	CAT. NO. 2377 Nylon Holster	CAT. NO. 2383 Nylon Holster	CAT. NO. 2407 Nylon Holster	CAT. NO. 7077 Plain Leather Holster	Cat. NO. 7078 Nylon Holster	Cat. NO. 7075 Basketweave Leather Holster	CAT. NO. 7106 Nylon Holster	CAT. NO. 7606 Nylon Holster	CAT. NO. 7607 Nylon Holster / Wand Kit	CAT. NO. 8057 Nylon Holster
HOLSTERS												
CAT. NO.												
2300	•											
2320	•											
2330	•											
2360		•										
2370			•									
2380			•									
2380R				•								
2340/NVG		•										
2400/NVG					•							
2400PL					•							
2450					•							
2410					•							
2410PL					•							
2460					•							
7000	•											
7060						•	•	•				
7100									•			
7600										•		
8040												•
8050												•

	CAT. NO. 700	CAT. NO. 750	CAT. NO. 770	CAT. NO. 780 FULL HOUSE	CAT. NO. 781 ACE	CAT. NO. 782 ALL IN	CAT. NO. 783 DOUBLE DOWN
HELMET HOLDERS							
CAT. NO.							
2140		•					
2250	•	•					
2300		•			•		
2320			•		•		
2330			•		•		
2340		•	•		•		
2350					•		
2360					•		
2370					•		
2380/2380R					•		
2390			•		•		
2400/PL	•	•	•	•			
2410/PL	•	•	•	•			
2430	•	•	•	•			
2450	•	•	•	•			
2460	•	•	•	•			
3310			•			•	
3315/PL			•			•	
3325						•	
3330			•		•		
7000					•		
All Headlamps							•

CAT. NO.	BATTERIES (included)	WEIGHT W/ BATTERIES (KG)	LENGTH (CM)	LUMENS	RUN TIME	BEAM SPREAD	NUMBER OF LED _s	LAMP HEADS	CERTIFICATIONS	COLORS
9420XL	Rechargeable Lithium ion	8.4 lbs. (3.8)	62.0" (157) [^]	1000*, 500***	2h*, 4h***	58°	2	1	N/A	■
9430	Rechargeable, Sealed Lead Acid	22.65 lbs. (10.27)	32.28" (82) [^]	3000*, 1500***	8h*, 15h***	125°	6	1	N/A	■ ■
9430SL	Rechargeable, Sealed Lead Acid	22.05 lbs. (10)	32.28" (82) [^]	2000*, 1000***	8h*, 15h***	10°	24	1	N/A	■
9440	Rechargeable Lithium ion	16.09 lbs. (7.3)	85" (215.8) [^]	5300*, 2800** 1400***	1h 30m*, 4h** 8h***	125°	12	1	N/A	■ ■
9455	Rechargeable NiMH	16 lbs. (7.3)	31.50" (80) [^]	1600*, 800***	5h*, 10h***	125°	10	1	CI D1, IECEx ia, ATEX Zone 0	■ ■
9460	Rechargeable, Sealed Lead Acid	61 lbs. (27.7)	79.50" (201.9) [^]	12,000 (variable)	3h*, 24h***	120°	10 per head	2	N/A	■ ■
9460M	Rechargeable, Sealed Lead Acid	64 lbs. (24.95)	79.50" (201.9) [^]	12,000 (variable)	3h*, 24h***	120°	10 per head	2	N/A	■ ■
9470	Rechargeable, Sealed Lead Acid	105 lbs. (47.6)	82.00" (208.3) [^]	24,000 (variable)	2h 45m*, 24h***	120°	10 per head	4	N/A	■ ■
9470M	Rechargeable, Sealed Lead Acid	108lbs. (49)	82.00" (208.3) [^]	24,000 (variable)	2h 45m*, 24h***	120°	10 per head	4	N/A	■ ■
9480	Rechargeable, Sealed Lead Acid	27.5 lbs. (12.47)	23.75" (60.3) [^]	4000*, 3000** 1000***	6h*, 8h** 28h***	125°	8	1	N/A	■ ■
9490	Rechargeable, Sealed Lead Acid	32 lbs. (14.51)	72" (182.8) [^]	6000 (variable)	3h 30m*, 12h** 24h***	125°	10	1	N/A	■ ■
9500	N/A	29.8 lbs. (13.52)	20.62" (52.4)	6000 (white LED) 1200 (red LED)	constant 120V	210° (diffused)	36	3	N/A	■

CAT NO.	BATTERIES	WEIGHT W/ BATTERIES (KG)	LENGTH (CM)	ANSI LIGHT OUTPUT	ANSI RUN TIME	ANSI BEAM DISTANCE (meters)	ANSI PEAK BEAM INTENSITY (candela)	ANSI IPX RATING	CERTIFICATIONS	COLORS
1810	4 LR 41 Alkaline (included)	0.5 oz. (0.01)	1.5" (3.8)	16	8h 30m	23	137	IPX4	N/A	■ ■ ■
1830	3 AAAA Alkaline (included)	1.2 oz. (0.03)	6.2" (15.7)	5	32h	13	44	IPX4	CI, D1	■ ■
1900	2 AAA Alkaline (included)	1.6 oz. (0.05)	4.09" (10.4)	11	1h 30m	45	571	IPX7	CI, D1/CII, D2	■ ■ ■ ■ ■ ■
1910	1 AAA Alkaline (included)	1.5 oz. (0.04)	3.8" (9.6)	106*, 21***	2h 30m*, 4h***	55*, 24***	765*, 140***	IPX7	N/A	■
1910	1 AAA Alkaline (included)	1.5 oz. (0.04)	3.8" (9.6)	72*, 14***	1h 45m*, 4h***	64*, 28***	1031*, 198***	IPX7	N/A	■ ■ ■ ■ ■
1920	2 AAA Alkaline (included)	2.2 oz. (0.06)	5.5" (14)	224*, 22***	2h 15m*, 8h 45m***	81*, 25***	1640*, 152***	IPX7	N/A	■
1920	2 AAA Alkaline (included)	2.2 oz. (0.06)	5.5" (14)	120*, 12***	2h 45m*, 8h 30m***	87*, 27***	1893*, 184***	IPX7	N/A	■ ■ ■ ■ ■
1930	4 LR 44 Alkaline (included)	0.9 oz. (0.03)	2.64" (6.7)	12	4h 15m	17	70	IPX4	CI, D1/CII, D2	■ ■
1965	2 AAA Alkaline (included)	1.9 oz. (0.05)	5.48" (13.9)	34	3h 45m	45	512	IPX7	CI II III, D1	■ ■
2140	2 AAA Alkaline (included)	1.8 oz. (0.05)	3.5" (8.9)	13	2h	84	1761	IPX7	CI, D2	■
2220	2 CR2032 Lithium (included)	1 oz. (0.03)	3.5" (8.9)	9	34h	12	38	IPX4	CI, D1	■ ■ ■
2300	2 AA Alkaline (included)	3.4 oz. (0.1)	5.62" (14.3)	11	4h 30m	43	478	IPX4	CI, D1/CII, D2	■ ■
2340	2 AA Alkaline (not included)	3.5 oz. (0.1)	6.25" (15.9)	10	4h 30m	43	461	IPX4	CI II, D2	■ ■

*High | **Medium | ***Low | ****Downcast | ^ Extended Height | Additional approvals may apply. For details go to www.pelican.com

CAT NO.	BATTERIES	WEIGHT W/ BATTERIES (KG)	LENGTH (CM)	ANSI LIGHT OUTPUT	ANSI RUN TIME	ANSI BEAM DISTANCE (meters)	ANSI PEAK BEAM INTENSITY (candela)	ANSI IPX RATING	CERTIFICATIONS	COLORS
1800	2 C Alkaline (not included)	7.8 oz. (0.22)	6" (15.2)	21	7h	131	4370	IPX7	CI II, D2	■ ■
1820	2 C Alkaline (included)	8.3 oz. (0.24)	5.83" (14.8)	22	6h 45m	146	5466	IPX7	CI II III, D2	■ ■
2000	3 C Alkaline (not included)	12.8 oz. (0.36)	7.79" (19.8)	53	5h	158	6234	IPX7	CI, D1/CII, D2	■ ■ ■
2000PL	3 C Alkaline (not included)	12.8 oz. (0.36)	7.79" (19.8)	53	5h	158	6234	IPX7	CI, D1/CII, D2	■
2010	3 C Alkaline (not included)	13.4 oz. (0.38)	8.11" (20.6)	161	22h	160	6398	IPX7	CI II III, D1	■ ■
2010PL	3 C Alkaline (not included)	13.4 oz. (0.38)	8.11" (20.6)	161	22h	160	6398	IPX7	CI II III, D1	■
2020	3 C Alkaline (not included)	14.7 oz. (0.42)	8.75" (22.2)	75	6h 30m	113	3211	IPX7	CI, D1	■ ■
2400	4 AA Alkaline (included)	7.1 oz. (0.2)	6.49" (16.5)	45	3h 45m	125	3934	IPX7	CI, D1/CII, D2	■ ■ ■ ■
2400PL	4 AA Alkaline (included)	7.1 oz. (0.2)	6.49" (16.5)	45	3h 45m	125	3934	IPX7	CI, D1/CII, D2	■
2410	4 AA Alkaline (included)	7.3 oz. (0.21)	7" (17.8)	183	5h 45m	184	8480	IPX7	CI II III, D1	■ ■
2410PL	4 AA Alkaline (included)	7.3 oz. (0.21)	7" (17.8)	183	5h 45m	184	8480	IPX7	CI II III, D1	■
2430	4 AA Alkaline (included)	6.1 oz. (0.17)	6.5" (16.5)	70	2h 15m	104	2766	IPX4	CI, D2	■ ■
2450	Rechargeable NiMH (included)	7.8 oz. (0.22)	6.5" (16.5)	35	3h 30m	122	3735	IPX7	CI II, D2	■ ■
2460	Rechargeable NiMH (included)	7.8 oz. (0.22)	7" (17.8)	183	5h	179	8050	IPX7	CI II, D2	■ ■
3310PL	3 AA Alkaline (included)	6.2 oz. (0.18)	6.14" (15.6)	378*, 39***	8h*, 202h***	196*, 62***	9580*, 961***	IPX8	N/A	■ (photoluminescent)
3310ELS	3 AA Alkaline (included)	6.2 oz. (0.18)	6.14" (15.6)	378*, 39***	8h*, 202h***	196*, 62***	9580*, 961***	IPX8	N/A	■ (photoluminescent)
3310R	Rechargeable Lithium-Ion (included)	5.4 (0.15)	6.11" (15.5)	1067 [®] , 403*, 21***	N/A [®] , 2h 30m*, 50h***	243 [®] , 149*, 34***	14808 [®] , 5591*, 281***	IPX8	N/A	■ ■
3315	3 AA Alkaline (included)	6.2 oz. (0.18)	6.14" (15.6)	160	19h	144	5153	IPX7	CI II III, D1	■ ■
3315R	Rechargeable Lithium-Ion (included)	6.2 oz. (0.18)	6.11" (15.5)	132*, 15***	5h*, 34h***	108*, 35***	2931*, 308***	IPX7	CI, D1	■ ■
3315PL	3 AA Alkaline (included)	6.2 oz. (0.18)	6.14" (15.6)	160	19h	144	5153	IPX7	CI II III, D1	■ (photoluminescent)
3325	3 AA Alkaline (included)	6.1 oz. (0.17)	6.06" (15.4)	162	16h	144	5215	IPX7	CI, D1	■
4000	8 D Alkaline (not included)	74.08 oz. (2.1)	9.37" (23.8)	249	11h	106	3168	IPX7	CI II, D2	■ ■ ■
9410L	Rechargeable Lithium-Ion (included)	44.7 oz. (1.27)	8.75" (22.2)	1203*, 553***	4h 30m*, 10h 30m***	430*, 287***	46,328*, 20,616***	IPX4	N/A	■ ■
9415	Rechargeable NiMH (included)	49.3 oz. (1.4)	8.75" (22.2)	413*, 159***	4h 30m*, 12h***	325*, 201***	26352*, 10076***	IPX4	CI, D1	■
2350	1 AA Alkaline (included)	3.4 oz. (0.1)	4.23" (10.7)	178*, 15***	2h 15m*, 21h***	130*, 37***	4196*, 345***	IPX7	N/A	■
2360	2 AA Alkaline (included)	5.4 oz. (0.15)	6.2" (15.7)	375*, 29***	2h 30m*, 13h***	192*, 53***	9187*, 705***	IPX8	N/A	■
2370	2 AA Alkaline (included)	6.5 oz. (0.18)	6.43" (16.3)	358*, 35***	2h*, 11h***	158*, 52***	9000*, 823***	IPX7	N/A	■
2380	2 AA Alkaline (included)	6.6 oz. (0.19)	6.44" (16.4)	372*, 31***	3h 30m*, 13h***	167*, 46***	6967*, 527***	IPX7	N/A	■

*High | **Medium | ***Low | ****Downcast | [®] Boost | Additional approvals may apply. For details go to www.pelican.com

	CAT NO.	BATTERIES	WEIGHT W/ BATTERIES (KG)	LENGTH (CM)	ANSI LIGHT OUTPUT	ANSI RUN TIME	ANSI BEAM DISTANCE (meters)	ANSI PEAK BEAM INTENSITY (candela)	ANSI IPX RATING	CERTIFICATIONS	COLORS
TACTICAL LIGHTS	2380R	Rechargeable Lithium-Ion (included)	6.6 oz. (0.19)	6.48" (16.5)	305°, 30***	3h 30m*, 25h***	159°, 50***	6317°, 613***	IPX7	N/A	■
	3330	2 CR123 Lithium (included)	3.45 oz. (0.1)	5.27" (13.4)	90	4h 45m	88	1959	IPX4	N/A	■ ■
	7000	2 CR123 Lithium (included)	5.6 oz. (0.16)	5.31" (13.5)	774°, 457**, 99***	1h 15m*, 1h 45m**, 13h***	246°, 176**, 83***	14768°, 7712**, 1738***	IPX7	N/A	■
	7060	Rechargeable Lithium-Ion (included)	10.4 oz. (0.29)	8.65" (22)	368°, 150**, 18***	3h*, 9h**, 45h***	199°, 125**, 43***	9953°, 3922**, 473***	IPX4	N/A	■
	7100	Lithium-Ion	4.4 oz. (0.13)	5.12" (13)	695°, 348**, 33***	1h 15m*, 1h 30m**, 9h 15m***	194°, 130**, 38***	9314°, 4247**, 358***	IPX8	N/A	■
	7600	Lithium-Ion	7.1 oz. (0.20)	6.19" (15.7)	944°, 479**, 37***	3h 15m*, 4h 30m**, 29h***	225°, 157**, 44***	12693°, 6172**, 480***	IPX8	N/A	■
	8050	Rechargeable NiMH (included)	17.92 oz. (0.51)	11.25" (28.6)	164	2h 15m	256	16448	IPX4	N/A	■ ■
	8060	Rechargeable NiMH (included)	23.2 oz. (0.66)	12.67" (32.2)	803°, 447**, 25***	2h 30m*, 4h**, 69h***	359°, 265**, 62***	32252°, 17492**, 958***	IPX4	N/A	■
	2600	4 AA Alkaline (included)	9.7 oz. (0.27)	3.81" (9.7)	18	3h 30m	27	203	IPX7	CI II III, D2	■
2610	3 AAA Alkaline (included)	3.2 oz. (0.09)	1.49" (3.8)	30°, 14***	19h*, 47h***	28°, 19***	194°, 91***	IPX4	CI, D1	■	
2620	3 AAA Alkaline (included)	4.8 oz. (0.14)	2.16" (5.5)	26°, 14***	2h 15m*, 18h**	44°, 29**	491°, 216**	IPX4	CI, D1	■	
2640	4 AA Alkaline (included)	10.9 oz. (0.31)	2.63" (6.7)	29°, 16***	2h 45m*, 17h**	46°, 20***	586°, 103***	IPX4	CI, D2	■	
2680	4 AA Alkaline (included)	9.7 oz. (0.27)	4.64" (11.8)	79	10h	123	3789	IPX7	CI II III, D2	■	
2690	3 AAA Alkaline (included)	4.1 oz. (0.12)	2.81" (7.1)	74	11h	92	2124cd	IPX7	CI II III, D1	■	
2720	3 AAA Alkaline (included)	3.8 oz. (0.11)	2.48" (6.3)	200°, 12***	3h*, 103h***	82°, 20***	1684°, 103***	IPX4	N/A	■	
2740	3 AAA Alkaline (included)	3.3 oz. (0.09)	2.25" (5.7)	66°, 36***	7h 15m*, 21h***	22°, 16***	122°, 68***	IPX4	N/A	■ ■ (translucent)	
2745	3 AAA Alkaline (included)	3.3 oz. (0.09)	2.25" (5.7)	33°, 17***	20h*, 40h***	35°, 25***	309°, 155***	IPX4	CI, D1	■ ■	
2750	3 AAA Alkaline (included)	3.4 oz. (0.1)	2.25" (5.7)	193°, 63***	3h*, 11h***	98°, 58***	1250°, 591***	IPX4	N/A	■ ■ (photoluminescent)	
2755	3 AAA Alkaline (included)	3.4 oz. (0.1)	2.25" (5.7)	72°, 34***	6h*, 15***	57°, 40***	807°, 404***	IPX4	CI, D1	■ ■	
2760	3 AAA Alkaline (included)	3.4 oz. (0.1)	2.25" (5.7)	204°, 141**, 95***, 42***	2h*, 3h 15m**, 5h***, 11h****	111°, 80**, 59***, 19***	3065°, 1606**, 861***, 88****	IPX4	N/A	■ ■ (translucent)	
2765	3 AAA Alkaline (included)	3.4 oz. (0.1)	2.25" (5.7)	105°, 104**, 65***, 33***	4h 15m*, 4h**, 6h 15m***, 9h****	107°, 93**, 63***, 9***	2876°, 2163**, 978***, 18****	IPX4	CI, D1	■ ■	
2780	4 AA Alkaline (included)	250 oz. (7.09)	3" (7.6)	430°, 203**, 53***	1h 30m*, 3h**, 12h***	127°, 81**, 27***	3868°, 1625**, 425***	IPX7	N/A	■ □ (photoluminescent)	
2780R	Rechargeable Lithium-Ion (included)	250 oz. (7.09)	3" (7.6)	558°, 213**, 95***	2h*, 3h**, 7h 30m***	127°, 78**, 53***	4060°, 1540**, 695***	IPX7	N/A	■ □ (photoluminescent)	
2785	4 AA Alkaline (included)	250 oz. (7.09)	3" (7.6)	226°, 103**, 33***	5h 45m*, 20h**, 66h***	111°, 74**, 41***	3058°, 1372**, 417***	IPX7	CI, D1	■ ■	

*High | **Medium | ***Low | ****Downcast | Additional approvals may apply. For details go to www.pelican.com

	CAT NO.	BATTERIES	WEIGHT W/ BATTERIES (KG)	LENGTH (CM)	ANSI LIGHT OUTPUT	ANSI RUN TIME	ANSI BEAM DISTANCE (meters)	ANSI PEAK BEAM INTENSITY (candela)	ANSI IPX RATING	CERTIFICATIONS	COLORS
RIGHT ANGLE LIGHTS	2250	2 AA Alkaline (included)	0.3 oz. (0.09)	3.87" (9.8)	7	5h 30m	54	726	IPX4	CI II, D2	■
	3310R-RA	Rechargeable Lithium-Ion (included)	5.4 (0.15)	8.27" (21)	948°, 385°, 20***	N/A®, 2h 30m*, 50h***	236°, 147°, 32***	13944°, 5424°, 267***	IPX8	N/A	■
	3315R-RA	Rechargeable Lithium-Ion (included)	6.2 oz. (0.18)	6.11" (15.5)	132°, 15***	5h*, 34h***	108°, 35***	2931°, 308***	IPX7	N/A	■
	3610	4 AA Alkaline (included)	10.5 oz. (0.3)	7.51" (19.1)	183	5h 45m	184	8480	IPX7	CI II III, D1	■ ■
	3610PL	4 AA Alkaline (included)	10.5 oz. (0.3)	7.51" (19.1)	183	5h 45m	184	8480	IPX7	CI II III, D1	■
	3660	Rechargeable 4 AA NiMH (included)	10.56 oz. (0.3)	7.51" (19.1)	183	5h	153	5828	IPX7	CI II, D2	■ ■
	3700	4 C Alkaline (not included)	20.32 oz. (0.58)	7" (17.8)	39°, 25 (back-up)	6h 15m*, 8h 30m (back-up)	98°, 51(back-up)	2437°, 684 (back-up)	IPX4	CI, D2	■
	3700PL	4 C Alkaline (not included)	20.32 oz. (0.58)	7" (17.8)	39°, 25 (back-up)	6h 15m*, 8h 30m (back-up)	98°, 51(back-up)	2437°, 684 (back-up)	IPX4	CI, D2	■
	3715	4 AA Alkaline (not included)	14.4 oz. (0.41)	5.36" (13.6)	233°, 113***, 31****	4h*, 7h***, 31h****	293°, 187***, 30****	21440°, 8775***, 220****	IPX4	CI, D1	■ ■
	3715PL	4 AA Alkaline (not included)	14.4 oz. (0.41)	5.36" (13.6)	233°, 113***, 31****	4h*, 7h***, 31h****	293°, 187***, 30****	21440°, 8775***, 220****	IPX4	CI, D1	■
	3750	Rechargeable NiCad (included)	20.48 oz. (0.58)	7" (17.8)	96°, 28 (back-up)	1h 45m*, 4h (back-up)	133°, 65 (back-up)	4468°, 1048 (back-up)	IPX4	CI, D2	■
	3750PL	Rechargeable NiCad (included)	20.48 oz. (0.58)	7" (17.8)	96°, 28 (back-up)	1h 45m*, 4h (back-up)	133°, 65 (back-up)	4468°, 1048 (back-up)	IPX4	CI, D2	■
	3765	Rechargeable NiMH (included)	14.6 oz. (0.41)	5.36" (13.6)	237°, 113***, 32****	3h*, 6h 30m***, 14h****	301°, 193***, 28****	22720°, 9354***, 192****	IPX4	CI, D1/CI, D2 (w/alkalines)	■ ■
	3765PL	Rechargeable NiMH (included)	14.6 oz. (0.41)	5.36" (13.6)	237°, 113***, 32****	3h*, 6h 30m***, 14h****	301°, 193***, 28****	22720°, 9354***, 192****	IPX4	CI, D1/CI, D2 (w/alkalines)	■
DIVE LIGHTS	1960N	2 AAA Alkaline (included)	1.9 oz. (0.05)	5.48" (13.9)	34	3h 30m	42	450	IPX8	N/A	■ ■ ■
	2010N	3 C Alkaline (not included)	13.4 oz. (0.38)	8.11" (20.6)	161	22h	260	6398	IPX8	N/A	■ ■ ■
	2410N	4 AA Alkaline (included)	7.3 oz. (0.21)	7" (17.8)	183	5h 45m	184	8480	IPX8	N/A	■ ■ ■
	2130	2 L1154 Alkaline (included)	0.5 oz. (0.01)	1.73" (4.4)	4.7 (non ANSI)	130h (non ANSI)	N/A	N/A	IPX7	N/A	■
	2130IR	2 L1154 Alkaline (included)	0.5 oz. (0.01)	1.73" (4.4)	N/A	65h (non ANSI)	N/A	N/A	IPX7	N/A	■
SPECIALTY LIGHTS	2365	2 AA Alkaline (not included)	9.3 oz. (0.26)	21.92" (55.7)	65	7h	81	1644	IPX4	N/A	■
	2490	4 AA Alkaline (not included)	8.2 oz. (0.23)	12.5" (31.7)	64	12h	118	3459	IPX7	N/A	□

*High | **Medium | ***Low | ****Downcast | Additional approvals may apply. For details go to www.pelican.com

